

INSTRUCTION MANUAL
MASSAGE CHAIR

TC-677

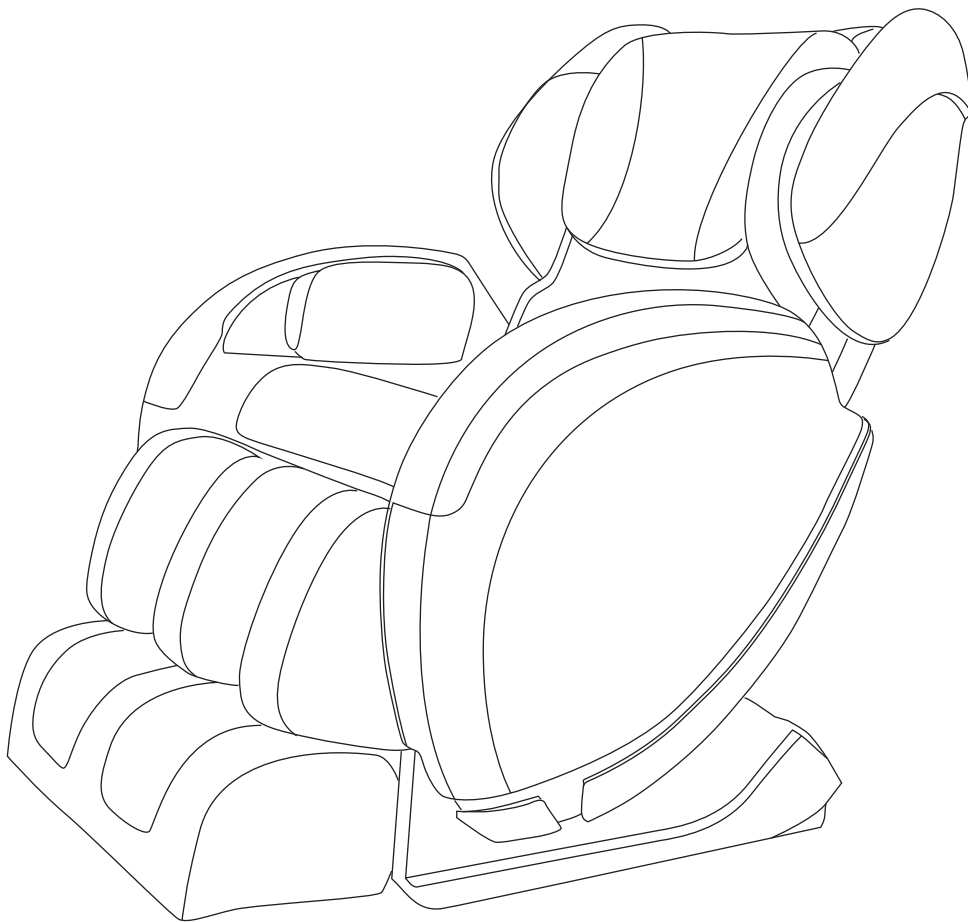

BE SURE TO READ THIS **INSTRUCTION MANUAL** CAREFULLY AND USE IT PROPERLY
AFTER USE, KEEP THIS MANUAL WITHIN REACH AT ALL TIME FOR FUTURE USE

CONTENTS

Thanks for purchasing our massage chair, hopefully the product will supply you really full and relax massage enjoyment. For service issues, please contact your local seller or manufacturer, never dismantle or repair by unauthorized people to avoid any hazard or product damaged.

IMPORTANT SAFETY INSTRUCTIONS.....	1-3
PARTS NAME.....	4-5
INSTRUCTIONS ON CONTROL PANEL	6-10
HOW TO OPERATE.....	11
CARE AND MAINTENANCE	12-13
SPECIFICATIONS.....	14

OPERATING SURROUNDINGS

- DO not use or Store the massage Chair under damp environment: i.e. bathroom, sauna, spa to avoid any moldy, electric shock, fire
- or mechanical failure.
- Don't use the massage chair outdoors
- Don't use the massage chair under dusty, smeary and anoxic conditions
- Don't place the massage chair near heater, stove or sunlight radiation to avoid inner components overheating to cause fire
- Make sure to place the massage chair on a flat level ground
- The bracket part should be placed on the plain ground
- To avoid an electric shock, please make sure to connect an earth wire
- Don't use the machine while smoking

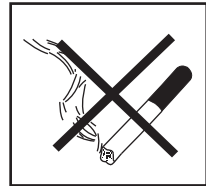
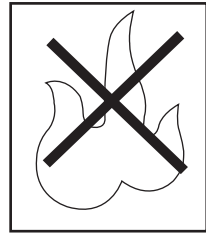

FOLLOWING CONDITIONS SHOULD CONSULT DOCTORS BEFORE USE

- Suffered from malignant tumor
- Serious heart disease
- Serious Skin disease
- Serious boned hyperplasia
- In pregnancy Of during the menses
- Be on the rest cure under the doctor's supervision
- The back bended exceptionally by the accident or disease
- Needing peaceful surroundings
- Arthritis disease
- Implanted pacemaker for medical PURpose
- Suffered from bowels disease (i.e. gastritis, entritis, diarrhea, hepatitis)
- Serious blood circulation trouble
- Consciousness trouble
- Be in hyper pyretic

WARNING

Children under 18 ages or special persons(as psychopath, the mental defects, the paralysis) close are not allowed to operate the massage chair, in case Of electric Shock, injurries or mechanism malfunctions.

IMPORTANT SAFETY INSTRUCTIONS

For safety reasons and in order to clearly indicate potential dangers should the product be used improperly, instructions have been marked in the following manners and should be strictly noted

CAUTIONS

Non-professional technicians are not allowed to dismantle or repair to avoid fire, electrical shock or serious hurt



DO not flush to the switch when cleaning to avoid insulation fault, electrical shock or short-circuit



When storing or maintenance, be sure to disconnect the power plug from socket



DO not detach the plug by wet hands

Make sure to shut off and detach the power plug when cleaning or storing product



During cleaning or moving the machine, make sure to detach power cord to avoid fire or electrical shock

DO not place the machine onto an unstable surface to avoid roast, insulation failure, electrical shock or turnover



When storing the machine, make sure to disconnect power plug to avoid fire caused by electricity leaking

Clean power plug periodically to avoid fire due to dust



Do not use it at any unsafe places or on Other purposes



It is the main reason of product damage or accident

Do not store the machine onto an unstable surface



Unexpected earthquake or external force will cause damage or injury

Keep Supply cord unobstructed at all time, i.e. not twisted, knotted, over flexed or pulled and do not place anything heavy on it



IMPORTANT SAFETY INSTRUCTIONS

CAUTIONS

DO not modify the structure or change components by unauthorized person

DO not dismantle the machine by unauthorized person to avoid electrical shock, short-circuit or fire



Do not store it near fire or flammable substances

It is one of the reasons of causing product torture, deviation or damage



Do not Should any abnormality occur(i.e. scorching smell), stop using immediately and detach power plug from socket

Keeping operating under an abnormal situation will cause fire or electrical shock, please contact your local seller or authorized service agent for maintenance



Do not place the machine onto an unstable surface to avoid roast, insulation failure, electrical shock or turnover



Only rated voltage must be used



Stop using immediately if supply cord or power plug be damaged or loosen



Be sure to keep children away during operating to avoid any hazard



Do not explore it under sunshine at all time



If the supply cord is damaged, it must be replaced by the manufacturer or its authorized persons for repair or maintenance to avoid any hazard

PRODUCT COMPONENTS

Main Body Diagram (Front)

CAUTIONS

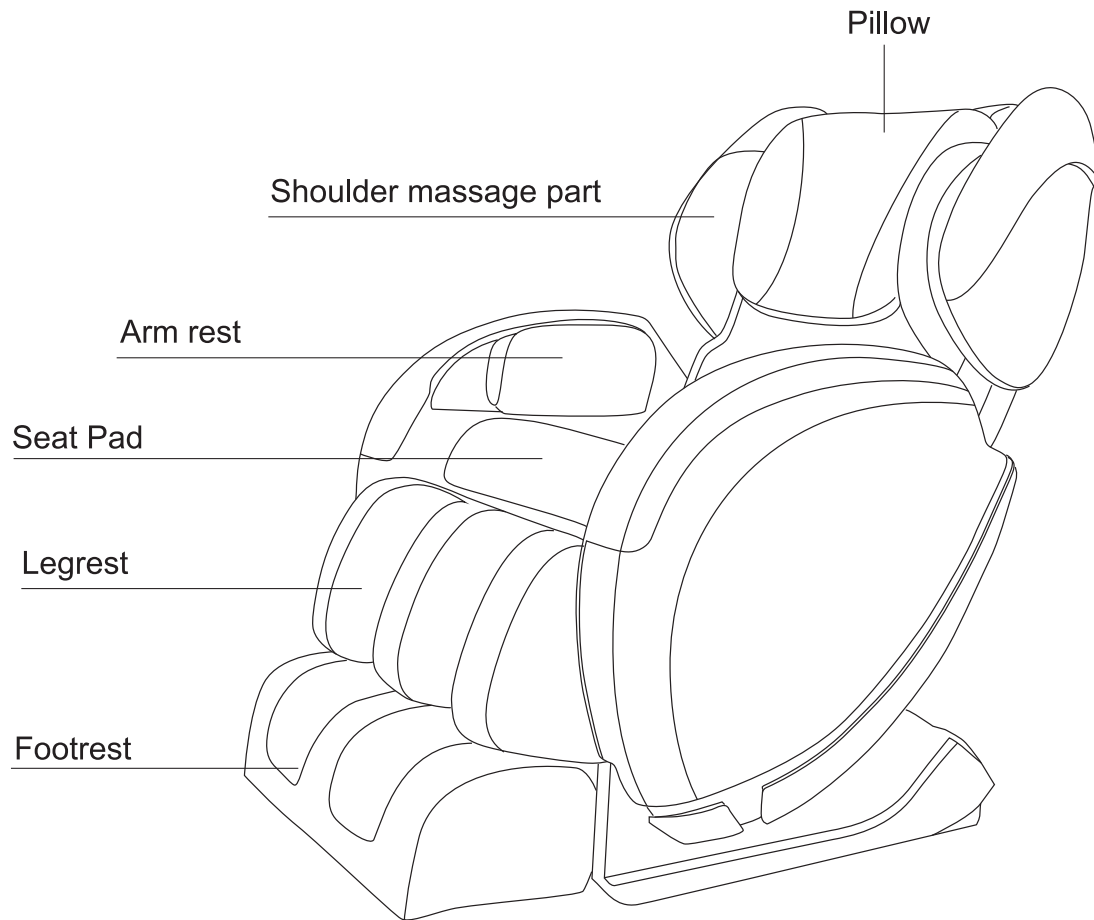

WARNING

1. Make sure not be twisted, knotted or stressed to the power cord or anything heavy on it.
2. The earth wire must be connected properly
3. Before attaching the plug, make sure all switches must be turned off
4. If the massage mechanism stays in the center of the backrest it will reset to the origin position at first

PRODUCT COMPONENTS

Main Body Diagram (Rear)

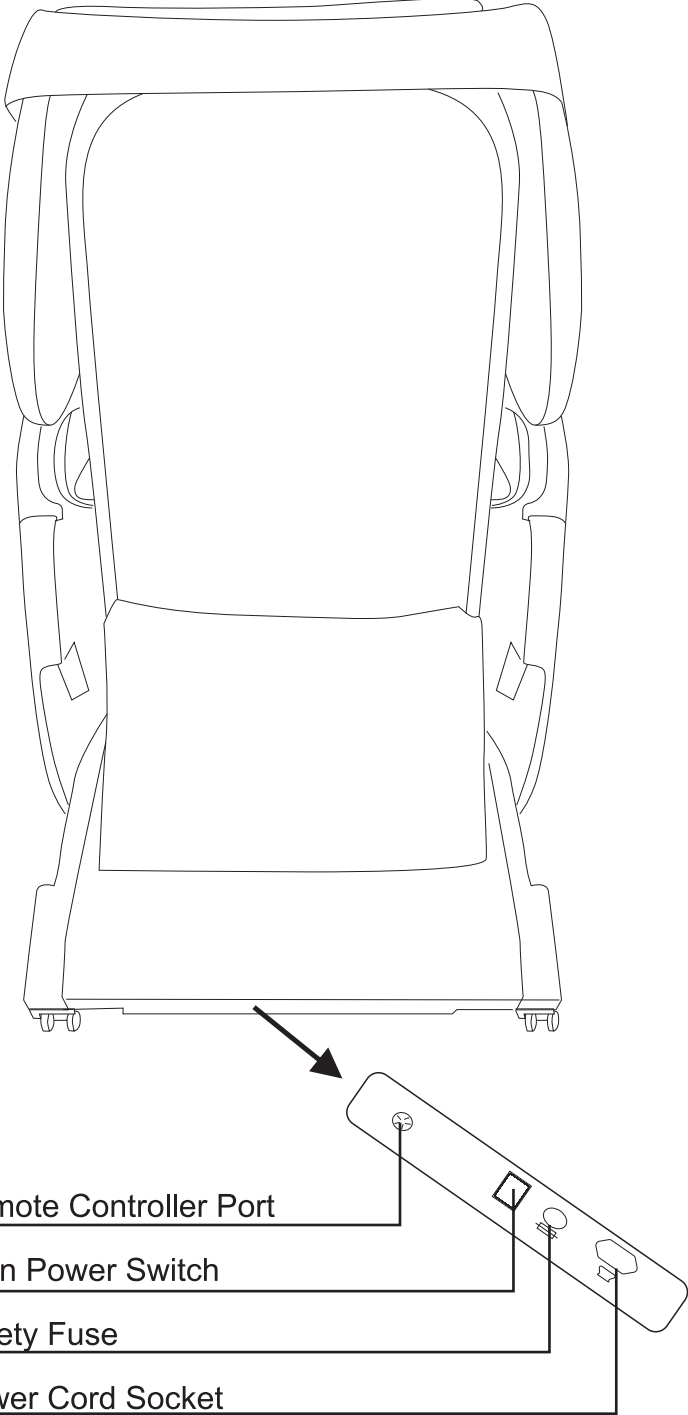

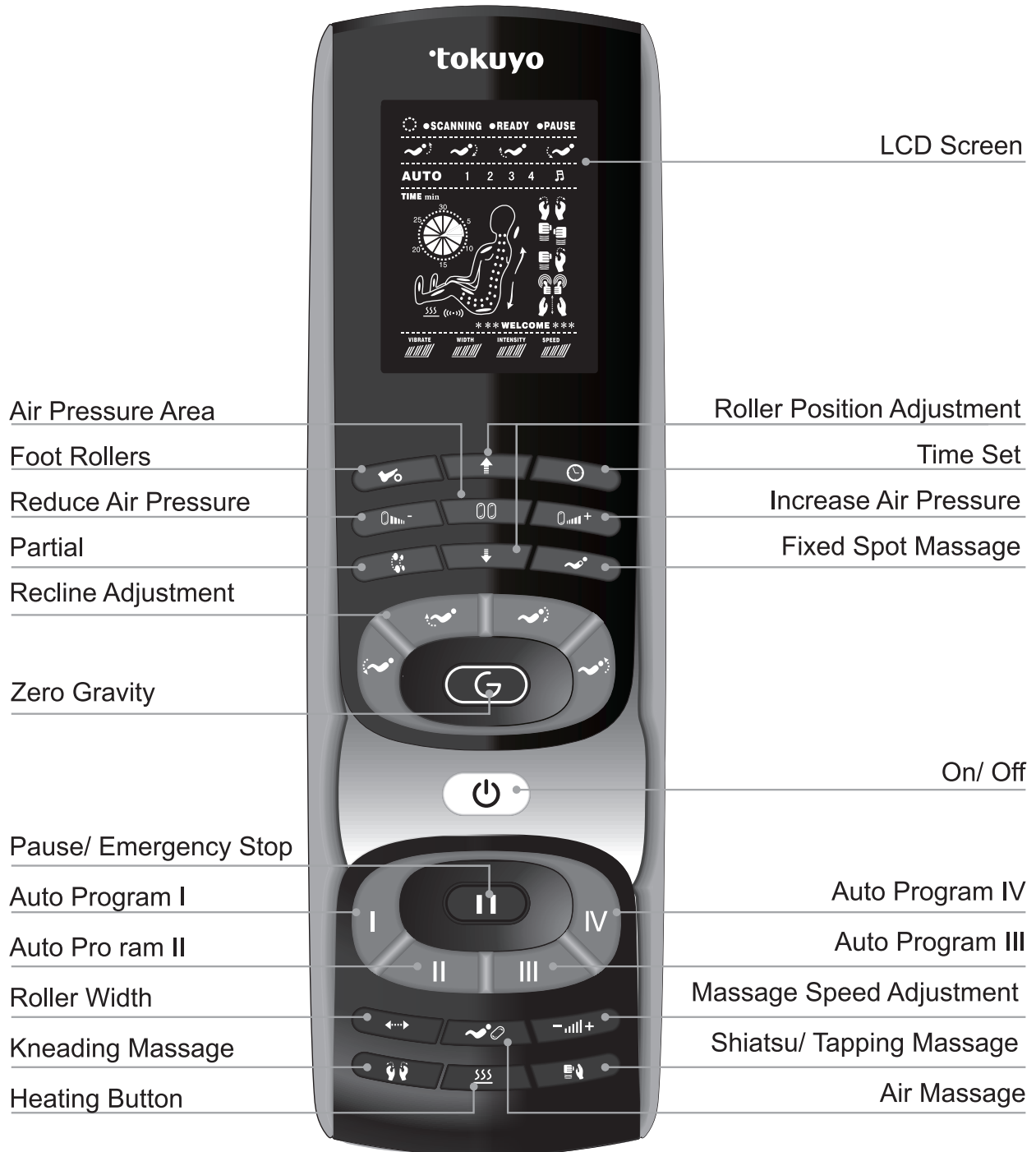

REMOTE CONTROLLER

CONTROLLER INSTRUCTIONS







CONTROLLER INSTRUCTIONS

START

Button	Name	Description
	ON/OFF	ON/OFF
	PAUSE	PAUSE

Position Adjustmen

Button	Name	Description
	Backrest Reclining	Press the button to recline the backrest
	Backrest Rising	Press the button to rise the backrest
	Footrest Rising	Press the button to rise the footrest
	Footrest Reclining	Press the button to recline the footrest
	Zero Gravity	Cycle like Zero Zero GO Upright

CONTROLLER INSTRUCTIONS

Auto Massage Programs

Each Program has different massage techniques: Shiatsu, Kneading, Tapping, Air Massage



Button	NAME	Description
I	Auto Program I	Whole body massage
II	Auto Program II	Lower body massage
III	Auto Program III	Upper body massage
IV	Auto Program IV	Stretching massage

*Above Auto Program massage time is 15 minutes, air pressure intensity is set at "Weak" .
Air pressure intensity is adjustable.

*Above Auto Programs are working individually.

Manual Massage Program : Kneading, Tapping, Shiatsu

Partial auto program is for partial body massage.

Button	Name	Description
	Kneading	Kneading massage for the back
	Knead & Tap	A kneading massage with tapping tap on the back
	Air Massage	Full body with air pressure



All above programs can't be used with auto programs.

All above programs are 15 minutes. Massage speed is set at medium and speed could be adjusted by pressing "Speed Adjustment Button" . The initial massage is set for the whole body and it could be changed to partial body or fixed point massage.

CONTROLLER INSTRUCTIONS

Air Pressure Massage

Air Pressure Massage Area and Intensity



Button	Name	Description
	Air Pressure Area Selection	To initiate/select each area of air pressure massage
	Increase Air Pressure	The levels of air pressure could be selected.
	Reduce Air Pressure	(Should be used with air pressure massage program.)

*Above Auto Program massage time is 15 minutes, air pressure intensity is set at "Weak" .
Air pressure intensity is adjustable.

*Above Auto Programs are working individually.

Foot Roller Massage & Heating function



On/Off for Foot Roller Massage

Button	Name	Description
	On/Off for Foot Roller Massage	On/Off for Foot Roller Massage
	Switch on/off for back heating	Switch on/off for back heating function

CONTROLLER INSTRUCTIONS



Select Massage Area

Selection of Partial Body Area and Fixed Point Massage These are for kneading and tapping massage.

	Name	Description
	Partial Body Massage	After pressing button, massage roller will move between up and down area.
	Fixed Point Massage	After pressing button, massage roller will stay at fixed point.
	Roller Position Adjustment	To adjust the up-down location of roller.

Select Massage Speed and Width

Selection of massage speed and width are only applied to kneading and tapping massage.

Button	Name	Description
	Massage Speed Adjustment	Selection of Massage Speed of Kneading. Three speed levels could be selected.
	Roller Width	Selection for the width of tapping. Three widths could be selected.
	Timer	Default timer at startup is set at 15 mins. Subsequently, every time the "TIMER " button is pressed, the Timer's interval will be changed in the sequence Of 30>25>20>15>10>5 minutes.

OPERATION GUIDE

Display Diagram

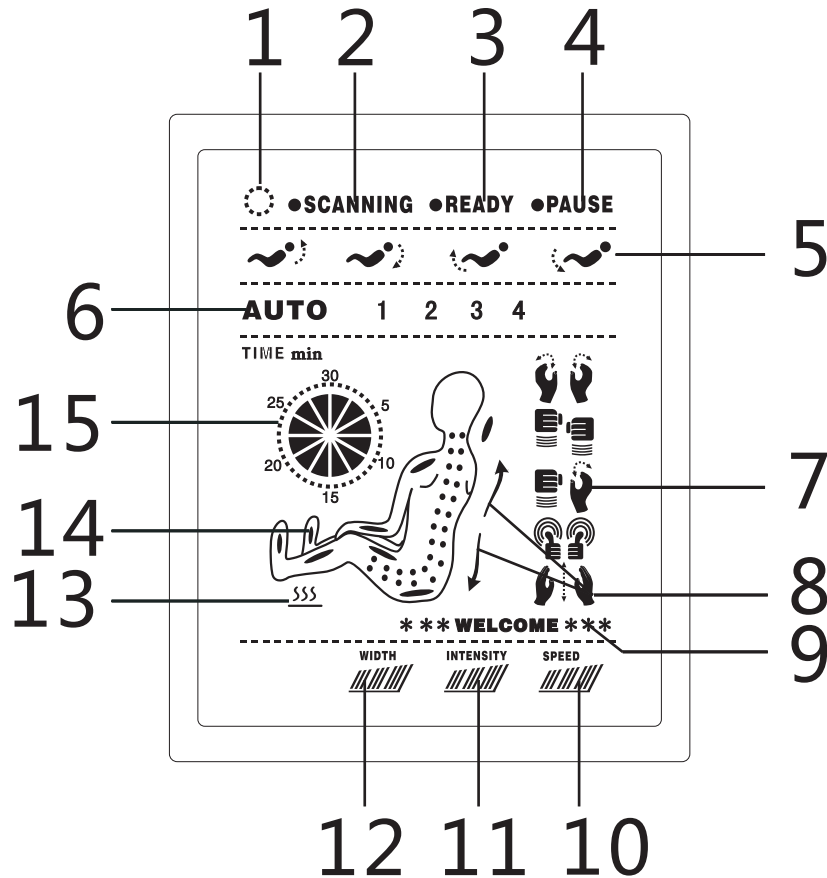

1. Massage Chair is powered on.
2. Massage chair is scanning the back contour and preparing for initiation
3. Scanning is complete and ready for massage programs.
4. Pause button has been pressed and chair is temporarily stopped.
5. Reclining position adjustment buttons are pressed the backrest and legrest are moving.
6. Displays which automatic program is activated
7. Displays which massage technique is activated at the time. In order from left to right: Kneading, Tapping, Knocking, Shiatsu and Rolling.
8. Shows the direction Of the massage rollers, moving upwards or downwards.
9. Cheerful greeting from your massage chair.
10. Shows the massage speed level from one bar to three bars illuminated.
11. Shows the air intensity level, from one to three.
12. Shows massage roller width, from narrow to medium to wide.
13. Heating function is on.
14. Displays the location of massage rollers and active air bags.
15. Shows the time remaining in current massage program.

CLEAN, CARE AND MAINTENANCE

■ Maintenance

- Please don't remove the backrest, it may cause electric shock by touching parts inside massage Chair.
- Please don't remove parts or repair massage chair by yourself. This may cause electric shock or accident.
- Please pull off the power plug when proceed maintenance.
- Please keep the massage chair clean and dustless. Please put the massage chair in dry area.
- If not use for a long time, please cover the massage chair with cloth to keep from dust.
- Please don't put massage chair under the sunlight directly.

■ Chair Maintenance

- Please clean the head pad, backrest pad and footrest by neutral detergents, and keep it dry after cleaning,
- Plastic part, tube and leather can be cleaned by cleaner also, mop it with dry cloth afterward
- Do not use organic cleaners such as benzene for cleaning, as it may cause leather discoloration, ageing and disintegration
- Please don't use the insecticide, it may cause an electric shock or fire.
- Use only dry cloth to clean the machine to prevent malfunction

■ Controller Maintenance

- Keep it away from fire and heat
- Please keep it in dry condition
- Please mop it with dry cloth softly or clean it with hairbrush.
- Do not use VOCs to clean (Such as volatile, organic compounds).

Please inspect this product when regularly use. If not use for a long time, please make sure this product can operate normally when use again.

Situations	Solutions
Indicator out and no operation	<ul style="list-style-type: none"> ● Please make sure the power plug is stable ● Please check the power switch is in the On position
Noise occurred When operating	<p>It is normal when following situations happen</p> <ul style="list-style-type: none"> ● When tapping or kneading action ● When adjust speed ● Sound from the frame when operating ● When massage ball rub the cloth ● When air press operating ● Vibrator noise (Especially when nobody lay on the chair) ● When adjusting the footrest ● When motor working on loaded

EMERGENCY SOLUTIONS

1. When abnormal situations, turn off the power and pull off the power plug
2. Call customer service for repair when it is breakdown.
3. Power Cord may only be replaced by the qualified personnel.

WARNING

To prevent fire or electric leakage, only qualified personnel may disassemble or fix the machine.

PRODUCT SPECIFICATION

MODEL NAME	TC -677
RATED INPUT VOLTAGE	<input type="checkbox"/> 100 ~ 120V <input type="checkbox"/> 220 ~ 240V
RATED FREQUENCY	<input type="checkbox"/> 50Hz <input type="checkbox"/> 60Hz
POWER CONSUMPTION	115W
N.W. / G.W.	98kg / 112KG
PRODUCT SIZE	L1310XW755XH1270 (mm)
CARTON SIZE	L1750XW770XH870 (mm)
ORIGINAL COUNTRY	China
SERIAL NO	

LIMITED WARRANTY

The Company will repair this product with new or rebuilt parts, free of charge for one year from the date of original purchase to the event of defect in material or workmanship.

A purchase invoice or any other proof of date of original purchase will be required before warranty performance is rendered. This warranty does not cover any damage which results from accident, misuse, abuse, alteration, modification or commercial use of this product.

This warranty is not available if the product is used in a health club or for any commercial purposes.

CUSTOMER NAME: _____

DATE: ___/___/___

DEALER NAME: _____

DEALER ADDRESS: _____
